

## **ADVANCED DEEP LEARNING TECHNIQUES FOR THE DETECTION AND CLASSIFICATION OF CARDIAC ARRHYTHMIAS USING IOT-ENABLED ECG SENSOR DATA**

Dr. Algubelly Yashwanth Reddy<sup>1</sup>, Nusrath Begum Mohammad<sup>1</sup>, Pushpa Latha Malgireddi<sup>1</sup>

<sup>1</sup>Department of Computer Science Engineering,

<sup>1</sup>Sree Dattha Group of Institutions, Sheriguda, Hyderabad, Telangana

### **ABSTRACT**

Cardiac arrhythmia is a disorder characterized by irregular heart beats. The World Health Organization (WHO) reports that over 17 million individuals globally succumb annually to cardiovascular illnesses. This is around 31% of total worldwide fatalities. The American Heart Association (AHA) reports that one in three fatalities in the United States is attributable to cardiovascular illnesses. Cardiovascular disease fatalities exceed those from all cancer types and chronic lower respiratory disorders combined. A 2014 study reveals that around 2 to 3% of individuals in North America and Europe are impacted by atrial fibrillation. A heart rate above 100 beats per minute in adults is termed tachycardia, whereas a heart rate below 60 beats per minute is referred to as bradycardia. If the beat occurs too early, it is termed a premature contraction. An irregular heartbeat is referred to as fibrillation or flutter. In addition to heart rate requirements, many categories for cardiac arrhythmia exist based on different parameters. Another categorization type pertains to the genesis point of the irregular heart rhythm. Cardiac arrhythmia is a disorder characterized by irregular heartbeats. This work aims to implement deep learning methodologies for diagnosing cardiac arrhythmia utilizing ECG signals with little data pre-processing. We utilize a one-dimensional convolutional neural network (1D-CNN) and long short-term memory (LSTM) to autonomously identify abnormalities. This study concentrates on the development of CNN and LSTM algorithms to predict arrhythmia illnesses throughout seven distinct phases. The MIT-BH dataset, encompassing seven distinct illness phases, is utilized to train both systems. The current LSTM yielded suboptimal accuracy. This study employed the CNN model for the training and testing of Arrhythmia illness.

**Keywords:** Cardiac arrhythmia, World Health Organization, one-dimensional convolutional neural network, long short-term memory.

## 1. INTRODUCTION

### 1.1 Overview

Cardiac arrhythmia is a condition where irregular heart rhythms occur. According to World Health Organization (WHO), about 17 million people in the world die every year due to cardiovascular diseases. This is about 31% of the total deaths globally. According to the statistics of American Heart Association (AHA), one out of every three deaths in US is related to cardiovascular diseases. The deaths due to cardiovascular diseases are more than due to all types of cancer and chronic lower respiratory diseases combined. A 2014 study indicates that approximately 2 to 3% of the people in North American and European countries are affected by atrial fibrillation. A heart rate which is high (above 100 beats per minute in adults) is called tachycardia and a heart rate that is slow (below 60 beats per minute) is called bradycardia.

If the beat is too early, then it is called premature contraction. Irregular beat is called fibrillation or flutter. Other than the criteria of heart rate, there are several other classifications for cardiac arrhythmia depending upon different types of criteria. Another type of classification is in terms of the site of origin of the irregular heart rate. Atrial arrhythmias originate in the atrioventricular (AV) node. The AV node is positioned between the atria (each of the two upper cavities of the heart from which blood is passed to the ventricles is referred to as atria) and the ventricles. Atrial fibrillation (AF), atrial flutter, atrial tachycardia, premature atrial contractions, and sinus bradycardia are some examples of atrial arrhythmias. Atrial fibrillation and atrial flutter are examples of arrhythmia which may lead to serious consequences.

In AF, the atrium is contracted in a very fast and irregular manner with the heart's electrical signals originating from a different part of the atria or in the adjacent pulmonary veins instead of sino-atrial (SA) node. The walls of the atria fibrillate (quiver very fast) instead of beating in a normal way, making atria unable to pump blood properly into the ventricles. Stroke and heart failure are two complications to which atrial fibrillation can lead to. Conditions like high blood pressure, overactive thyroid gland, coronary and rheumatic heart diseases can lead to AF. Atrial flutter has similar symptoms and complications as AF. But in atrial flutter, the advancement of electrical signals of the heart through the atria happens in a fast and regular manner instead of the irregular way it happens in AF.

Ventricular arrhythmias are premature rhythms occurring in an ectopic ventricular focus. Ventricular fibrillation, ventricular tachycardia, premature ventricular contractions are some examples of ventricular arrhythmias. Some arrhythmias are symptomless and not at all life threatening. But some symptomless arrhythmias can even lead to serious complications like blood clotting, stroke, heart failure and sudden cardiac death. Arrhythmias occur when the electrical signals to the heart that co-ordinate

# ADVANCED DEEP LEARNING TECHNIQUES FOR THE DETECTION AND CLASSIFICATION OF CARDIAC ARRHYTHMIAS USING IOT-ENABLED ECG SENSOR DATA

heartbeat are not working properly. The first step in the diagnosis of this abnormality is the analysis of electrocardiogram (ECG) and the confirmation that the ECG is not indicative of cardiac arrhythmia.

ECG is a bio signal representing the activity of the autonomous nervous system (ANS) controlling heart rhythm. Thus, the electrical activity of the heart is recorded in ECG. It is a non-invasive and efficient tool to study cardiac rhythms and diagnose arrhythmias. The ECG signal is generated because of the following processes. The heartbeat is originated as an electric pulse from the SA node situated in the right atrium of the heart. After contracting both atria, this electric pulse, then activates atrioventricular (AV) node that connects electrically the atria and the ventricles. This is followed by the activation of both ventricles. The complete heart activity is represented in the ECG waveform. Abnormalities in the morphology of ECG waveforms are indicators of cardiac arrhythmias. ECG waveform is analysed to ascertain the risk associated with any type of arrhythmia.

## 1.2 Problem statement

Extensive research has been done in arrhythmia detection. The below are works in a serious type of arrhythmia called as myocardial infarction (MI) commonly known as heart attack. Data from a single lead ECG was used for MI detection achieving an accuracy of 94.74% [1]. Multiscale eigenspace analysis was carried out on 12 lead ECG data to achieve the same objective with an accuracy of 96% [2]. Analysis of 12 nonlinear parameters extracted from 12 lead ECG data using discrete wavelet transform (DWT) were used to detect MI to achieve an accuracy of 98.8% [3]. Deep learning techniques are now being increasingly employed in this area. The automated detection of normal and MI was conducted with CNN with an accuracy of 95.22% [4]. An accuracy of 84.54% was achieved in the detection of inferior MI in ECG using CNN [5]. Four types of arrhythmias were classified with an accuracy of 99.38% with MIT BIH data set along with another dataset as input [4]. Classification of MIT Arrhythmia database of ECG into normal and abnormal was conducted using artificial neural network (ANN) achieving an accuracy of 96.77% [5].

There are many works of classifying specific types of cardiac arrhythmia with ECG as normal input data. Often these specific cardiac arrhythmia cases addressed in most of the previous research work will be serious arrhythmia types like myocardial infarction. In short, research was conducted into classifying normal ECG and many types of arrhythmias affected ECG. Cardiac arrhythmia, though identified by the irregularity in cardiac rhythm, is due to the anomalies happening in the heart. These anomalies cause anatomical differences in the structure of atria and ventricles, thus producing changes in its activation, depolarization, and repolarisation. These changes are reflected as deviation of ECG waveform from its normal shape and size. Different types of cardiac arrhythmia are caused by unique factors, thus causing unique changes in the morphology of the ECG wave [6], [7], [8].

## 1.2 Motivation

Cardiac arrhythmia is a significant global health issue, contributing to a substantial portion of deaths worldwide. Current statistics highlight the urgency for effective diagnostic tools and interventions to address this problem. Traditional methods for diagnosing cardiac arrhythmias often rely on manual interpretation of electrocardiogram (ECG) signals, which can be time-consuming and prone to human error. The motivation behind this research is to leverage advanced deep learning techniques to develop an automated system that can accurately detect and classify cardiac arrhythmias using ECG data. By automating this process, timely diagnosis and intervention can be facilitated, potentially reducing the morbidity and mortality associated with cardiovascular diseases.

## 1.3 Objective

The objective of this study is to apply deep learning techniques, specifically one-dimensional convolutional neural networks (1D-CNN) and long short-term memory (LSTM) networks, for the automated detection and classification of cardiac arrhythmias using ECG signals. The primary goal is to design and optimize CNN and LSTM algorithms capable of accurately predicting arrhythmia diseases at various stages. Additionally, the research aims to minimize data preprocessing steps to streamline the diagnostic process and maximize efficiency. The ultimate objective is to develop a robust and reliable system that can assist healthcare professionals in diagnosing cardiac arrhythmias quickly and accurately.

## 2. LITERATURE SURVEY

Jafarnia et al. used two new features i.e., T-wave integral and total integral as extracted feature from one cycle of normal and patient ECG signals to detection and localization of myocardial in-fraction (MI) in left ventricle of heart. And used the T-wave integral because this feature is important impression of T-wave in MI. The second feature in this research is total integral of one ECG cycle, because that the MI affects the morphology of the ECG signal which leads to total integral changes. Also, this work can improve the accuracy of classification by adding more features in this method. A simple method based on using only two features which were extracted from standard ECG is presented and had good accuracy in MI localization.

Sharma et al. studied the multiscale wavelet energies and eigenvalues of multiscale covariance matrices are used as diagnostic features. Support vector machines (SVMs) with both linear and radial basis function (RBF) kernel and K-nearest neighbor are used as classifiers. Datasets, which include healthy control, and various types of MI, such as anterior, anteriolateral, anterioseptal, inferior, inferiolateral, and inferioposterio-lateral, from the PTB diagnostic ECG database are used for evaluation. The results showed that the proposed technique can successfully detect the MI pathologies.

## **ADVANCED DEEP LEARNING TECHNIQUES FOR THE DETECTION AND CLASSIFICATION OF CARDIAC ARRHYTHMIAS USING IOT-ENABLED ECG SENSOR DATA**

Acharya et al. proposed a novel method of automated detection and localization of MI by using ECG signal analysis. In this study, a total of 200 twelve lead ECG subjects (52 normal and 148 with MI) involving 611,405 beats (125,652 normal beats and 485,753 beats of MI ECG) are segmented from the 12 lead ECG signals. Firstly, ECG signal obtained from 12 ECG leads are subjected to discrete wavelet transform (DWT) up to four levels of decomposition. Then, 12 nonlinear features are extracted from these DWT coefficients. The extracted features are then ranked based on the t value. This proposed method has achieved the highest average accuracy of 98.80%, sensitivity of 99.45% and specificity of 96.27% in classifying normal and MI ECG (two classes), by using 47 features obtained from lead 11 (V5).

Mohammadzadeh and Setarehdan used a neural network classifier to automatic classification of cardiac arrhythmias into five classes. HRV signal is used as the basic signal and linear and nonlinear parameters extracted from it are used to train a neural network classifier. The proposed approach is tested using the MIT-BIH arrhythmia database and satisfactory results were obtained with an accuracy level of 99.38%.

Vishwa et al. proposed an automated Artificial Neural Network (ANN) based classification system for cardiac arrhythmia using multi-channel ECG recordings. In this study, producing high confident arrhythmia classification results to be applicable in diagnostic decision support systems. The classification performance is evaluated using measures; sensitivity, specificity, classification accuracy, mean squared error (MSE), receiver operating characteristics (ROC) and area under curve (AUC). Experimental results give 96.77% accuracy on MIT-BIH database and 96.21% on database prepared by including NSR database also.

Swapna et al. discussed the characteristics and different methods (and their measures) of analyzing the heart rate variability (HRV) signal, derived from the ECG waveform. The HRV signals are characterised in terms of these measures, then fed into classifiers for grouping into categories (for normal subjects and for disorders such as cardiac disorders and diabetes) for carrying out diagnosis.

Sujadevi et al. explored and employed a deep learning method such as RNN, LSTM and GRU to detect the Atrial Fibrillation (AF) faster in the given electrocardiogram traces. This study used one of the well-known publicly available MIT-BIH Physionet datasets. This is the first time Deep learning has been employed to detect the Atrial Fibrillation in real-time. Based on this work experiments RNN, LSTM and GRU offer the accuracy of 0.950, 1.000 and 1.000 respectively. This methodology does not require any de-noising, other filtering, and preprocessing methods. Results are encouraging enough to begin clinical trials for the real-time detection of AF that will be highly beneficial in the scenarios of ambulatory, intensive care units and for real-time detection of AF for life saving implantable defibrillators.

Pathinarupothi et al. applied a deep learning technique called LSTM-RNN (long short-term memory recurrent neural network) for identification of sleep apnea and its severity based only on instantaneous heart rates. This tested this model on multiple sleep apnea datasets and obtained perfect accuracy. Furthermore, this work has also tested its robustness on an arrhythmia dataset (that is highly probable in mimicking sleep apnea heart rate variability) and found that the model is highly accurate in distinguishing between the two.

Goldberger et al. of cardiovascular and other complex biomedical signals. The resource has 3 interdependent components. PhysioBank is a large and growing archive of well-characterized digital recordings of physiological signals and related data for use by the biomedical research community. It currently includes databases of multiparameter cardiopulmonary, neural, and other biomedical signals from healthy subjects and from patients with a variety of conditions with major public health implications, including life-threatening arrhythmias, congestive heart failure, sleep apnea, neurological disorders, and aging. PhysioToolkit is a library of open-source software for physiological signal processing and analysis, the detection of physiologically significant events using both classic techniques and novel methods based on statistical physics and nonlinear dynamics, the interactive display and characterization of signals, the creation of new databases, the simulation of physiological and other signals, the quantitative evaluation and comparison of analysis methods, and the analysis of nonstationary processes. PhysioNet is an on-line forum for the dissemination and exchange of recorded biomedical signals and open-source software for analyzing them. It provided facilities for the cooperative analysis of data and the evaluation of proposed new algorithms.

Gers et al. reviewed an illustrative benchmark problem on which standard LSTM outperforms other RNN algorithms. All algorithms (including LSTM) fail to solve a continual version of that problem. LSTM with forget gates, however, easily solves it in an elegant way.

### **3. PROPOSED METHOD**

#### **3.1 Overview**

This Python code is a graphical user interface (GUI) application built using the Tkinter library. The purpose of the application is to demonstrate the automated detection of cardiac arrhythmia using deep learning models, specifically Long Short-Term Memory (LSTM) and Convolutional Neural Network (CNN).

- Imports: The code imports various libraries and modules necessary for different functionalities, including Tkinter for GUI, pandas for data manipulation, numpy for numerical operations, matplotlib and seaborn for data visualization, and keras for deep learning model building and training.

# ADVANCED DEEP LEARNING TECHNIQUES FOR THE DETECTION AND CLASSIFICATION OF CARDIAC ARRHYTHMIAS USING IOT-ENABLED ECG SENSOR DATA

- **GUI Setup:** The main GUI window is created using Tkinter. It sets the title, geometry, and size of the window.
- **Buttons and Labels:** Several buttons are created for different actions such as uploading a dataset, preprocessing the dataset, running LSTM and CNN algorithms, displaying training graphs, generating performance tables, and exiting the application. Labels are also used to display information such as the path of the uploaded dataset.
- **Function Definitions:** Functions are defined for various actions performed by the buttons. These functions include uploading a dataset, preprocessing the dataset, running LSTM and CNN algorithms, calculating performance metrics, displaying training graphs, generating performance tables, and exiting the application.
- **Dataset Handling:** The code allows users to upload a dataset in CSV format containing ECG data. The dataset is then preprocessed, which involves filling missing values, encoding categorical labels, shuffling the data, normalizing features, and performing principal component analysis (PCA) for dimensionality reduction.
- **Model Training and Evaluation:** The LSTM and CNN models are trained using the preprocessed dataset. If saved model weights are available, they are loaded; otherwise, new models are created and trained. The models are evaluated using accuracy, precision, recall, F1-score, sensitivity, specificity, and confusion matrix.
- **Data Visualization:** The code includes functionality to display training graphs showing the accuracy and loss of LSTM and CNN models over epochs. It also visualizes confusion matrices for both models.
- **Performance Table:** A performance table is generated displaying the evaluation metrics for LSTM and CNN models on the uploaded dataset.
- **Exit:** An exit button allows users to close the application.

## 3.2 Proposed Model

Cardiac arrhythmia is a condition where irregular heart rhythms occur. According to World Health Organization (WHO), about 17 million people in the world die every year due to cardiovascular diseases. This is about 31% of the total deaths globally. According to the statistics of American Heart Association (AHA), one out of every three deaths in US is related to cardiovascular diseases. The deaths due to cardiovascular diseases are more than due to all types of cancer and chronic lower respiratory diseases combined. A 2014 study indicates that approximately 2 to 3% of the people in North American and European countries are affected by atrial fibrillation. A heart rate which is high (above 100 beats per minute in adults) is called tachycardia and a heart rate that is slow (below 60 beats per minute) is

called bradycardia. If the beat is too early, then it is called premature contraction. Irregular beat is called fibrillation or flutter. Other than the criteria of heart rate, there are a number of other classifications for cardiac arrhythmia depending upon different types of criteria. Another type of classification is in terms of the site of origin of the irregular heart rate.

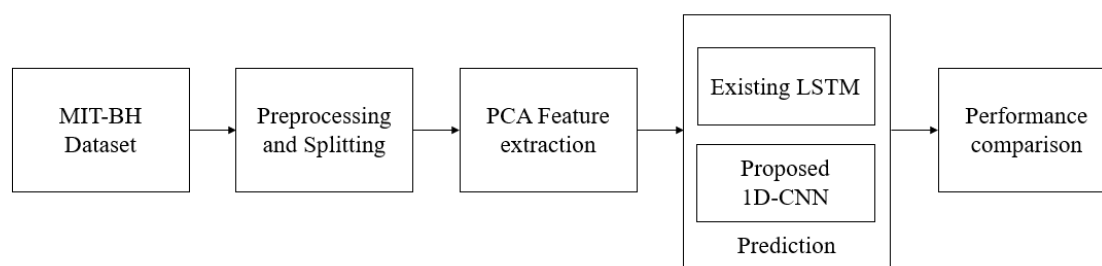

Fig. 3.1: Proposed block diagram.

Cardiac arrhythmia is a condition where heart beat is irregular. The goal of this paper is to apply deep learning techniques in the diagnosis of cardiac arrhythmia using ECG signals with minimal possible data pre-processing. We employ deep learning convolutional neural network (1D-CNN), and long short-term memory (LSTM) to automatically detect the abnormality. This work is focused on the design of CNN and LSTM algorithms to predict Arrhythmia diseases with 7 different stages. To train both algorithms, the MIT-BH dataset is used with 7 different disease stages. Further, existing LSTM resulted in low accuracy. So, this work adopted the CNN model for training and testing Arrhythmia disease.

Fig 4.1 shows the block diagram of proposed. Here, MIT-BH dataset is considered for evaluating the performance of overall system. Initially, the dataset is splitted into 80% for training and 20% for testing. Then, the entire operations are going to be perform on both training and testing datasets. Further, pre-processing operation is carried out to remove the missing symbols and unknown characters, special characters. The pre-processing operation also normalizes the number of rows and columns presented in the dataset. Further, both LSTM and 1D-CNN models are applied to evaluate the prediction of MITBH dataset. So, through this prediction it is going to identify the cardiac arrhythmia presented in overall dataset. Finally, performance comparison is takes place between both LSTM and 1D-CNN models.

### 3.3 MIT-BH Dataset

The MIT-BIH Arrhythmia Database contains 48 half-hour excerpts of two-channel ambulatory ECG recordings, obtained from 47 subjects studied by the BIH Arrhythmia Laboratory between 1975 and 1979. Twenty-three recordings were chosen at random from a set of 4000 24-hour ambulatory ECG recordings collected from a mixed population of inpatients (about 60%) and outpatients (about 40%) at Boston's Beth Israel Hospital; the remaining 25 recordings were selected from the same set to include



# ADVANCED DEEP LEARNING TECHNIQUES FOR THE DETECTION AND CLASSIFICATION OF CARDIAC ARRHYTHMIAS USING IOT-ENABLED ECG SENSOR DATA

less common but clinically significant arrhythmias that would not be well-represented in a small random sample.

The recordings were digitized at 360 samples per second per channel with 11-bit resolution over a 10-mV range. Two or more cardiologists independently annotated each record; disagreements were resolved to obtain the computer-readable reference annotations for each beat (approximately 110,000 annotations in all) included with the database. This directory contains the entire MIT-BIH Arrhythmia Database. About half (25 of 48 complete records, and reference annotation files for all 48 records) of this database has been freely available here since PhysioNet's inception in September 1999.

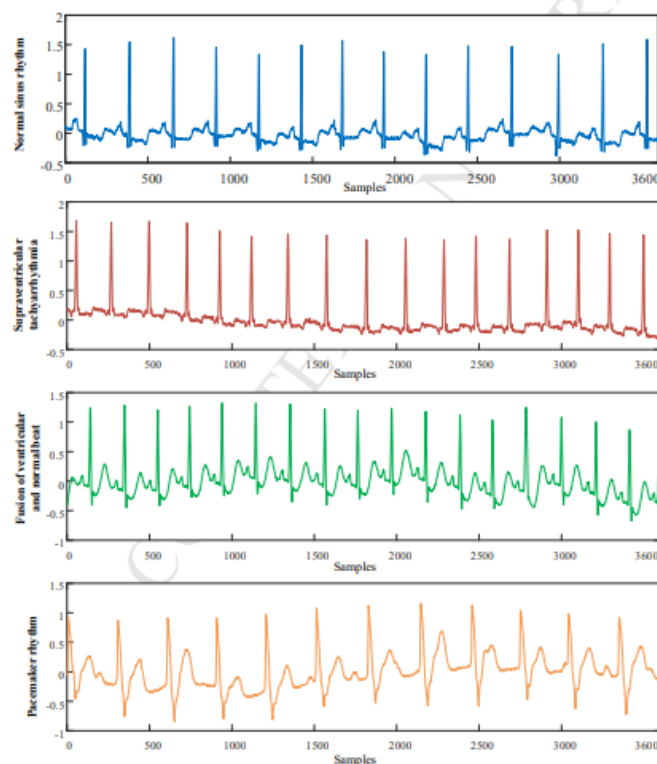

Fig. 3.2: Typical signal samples of different classes.

Finally, the dataset contains 'Normal heart', 'Ischemic changes (coronary artery disease)', 'Old Anterior Myocardial Infarction', 'Old Inferior Myocardial Infarction', 'Sinus tachycardia', 'Sinus bradycardia', 'Right bundle branch block' as disease classes.

## CNN Classifier

According to the facts, training and testing of CNN involves in allowing every source data via a succession of convolution layers by a kernel or filter, rectified linear unit (ReLU), max pooling, fully

connected layer and utilize SoftMax layer with classification layer to categorize the objects with probabilistic values ranging from.

Convolution layer is the primary layer to extract the features from a source image and maintains the relationship between pixels by learning the features of image by employing tiny blocks of source data. It's a mathematical function which considers two inputs like source image  $I(x, y, d)$  where  $x$  and  $y$  denotes the spatial coordinates i.e., number of rows and columns.  $d$  is denoted as dimension of an image (here  $d=3$  since the source image is RGB) and a filter or kernel with similar size of input image and can be denoted as  $F(k_x, k_y, d)$ .

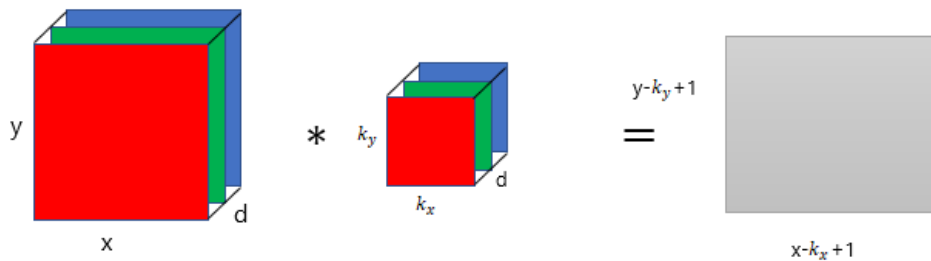
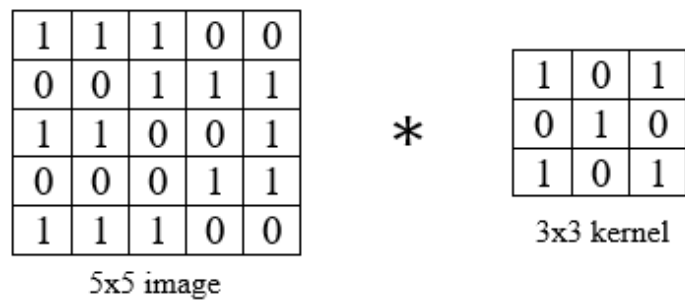
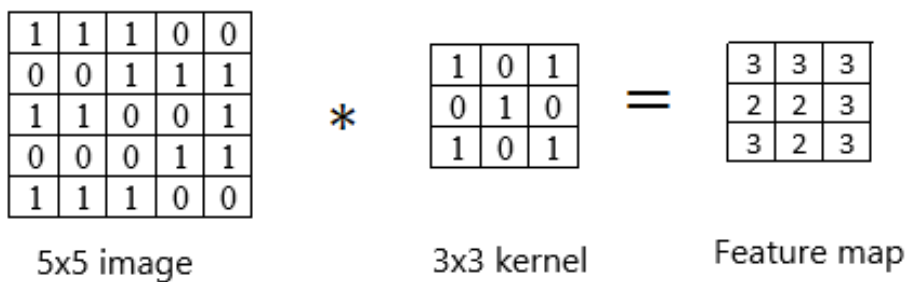

Fig. 3.3: Representation of convolution layer process.

The output obtained from convolution process of input image and filter has a size of  $C((x - k_x + 1), (y - k_y + 1), 1)$ , which is referred as feature map. Let us assume an input image with a size of  $5 \times 5$  and the filter having the size of  $3 \times 3$ . The feature map of input image is obtained by multiplying the input image values with the filter values.



(a)



# ADVANCED DEEP LEARNING TECHNIQUES FOR THE DETECTION AND CLASSIFICATION OF CARDIAC ARRHYTHMIAS USING IOT-ENABLED ECG SENSOR DATA

(b)

Fig. 3.4: Example of convolution layer process (a) an image with size  $5 \times 5$  is convolving with  $3 \times 3$  kernel (b) Convolved feature map.

## ReLU layer

Networks those utilizes the rectifier operation for the hidden layers are cited as rectified linear unit (ReLU). This ReLU function  $\mathcal{G}(\cdot)$  is a simple computation that returns the value given as input directly if the value of input is greater than zero else returns zero. This can be represented as mathematically using the function  $\max(\cdot)$  over the set of 0 and the input  $x$  as follows:

$$\mathcal{G}(x) = \max\{0, x\}$$

## Max pooling layer

This layer mitigates the number of parameters when there are larger size images. This can be called as subsampling or down sampling that mitigates the dimensionality of every feature map by preserving the important information. Max pooling considers the maximum element from the rectified feature map.

## Softmax classifier

Generally, as seen in the above picture softmax function is added at the end of the output since it is the place where the nodes are meet finally and thus, they can be classified. Here,  $X$  is the input of all the models and the layers between  $X$  and  $Y$  are the hidden layers and the data is passed from  $X$  to all the layers and Received by  $Y$ . Suppose, we have 10 classes, and we predict for which class the given input belongs to. So, for this what we do is allot each class with a particular predicted output. Which means that we have 10 outputs corresponding to 10 different class and predict the class by the highest probability it has.

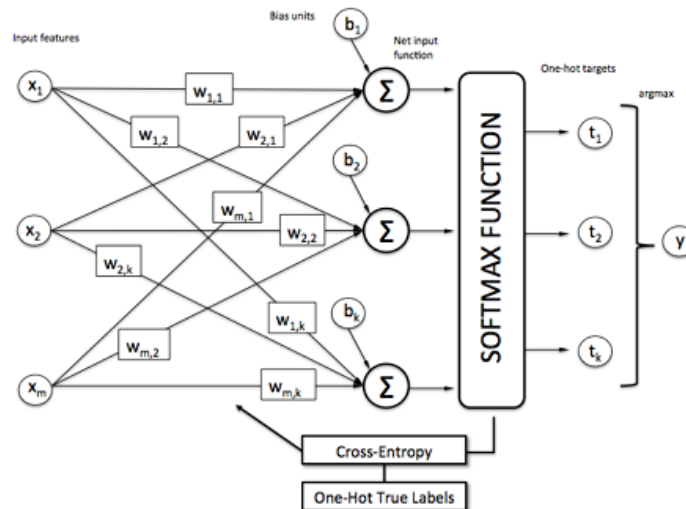

Fig. 3.5: Vehicle prediction using SoftMax classifier.

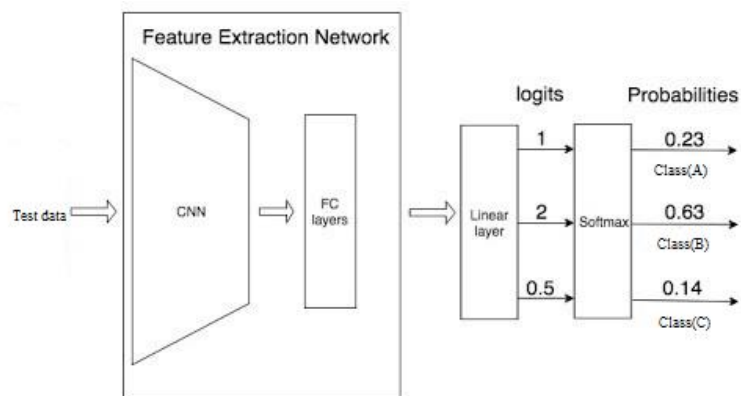

Fig. 3.6: Example of SoftMax classifier.

In Figure 8, and we must predict what is the object that is present in the picture. In the normal case, we predict whether the crop is A. But in this case, we must predict what is the object that is present in the picture. This is the place where softmax comes in handy. As the model is already trained on some data. So, as soon as the picture is given, the model processes the pictures, send it to the hidden layers and then finally send to softmax for classifying the picture. The softmax uses a One-Hot encoding Technique to calculate the cross-entropy loss and get the max. One-Hot Encoding is the technique that is used to categorize the data. In the previous example, if softmax predicts that the object is class A then the One-Hot Encoding for:

Class A will be [1 0 0]

Class B will be [0 1 0]

Class C will be [0 0 1]

# ADVANCED DEEP LEARNING TECHNIQUES FOR THE DETECTION AND CLASSIFICATION OF CARDIAC ARRHYTHMIAS USING IOT-ENABLED ECG SENSOR DATA

From the diagram, we see that the predictions are occurred. But generally, we don't know the predictions. But the machine must choose the correct predicted object. So, for machine to identify an object correctly, it uses a function called cross-entropy function.

So, we choose more similar value by using the below cross-entropy formula.

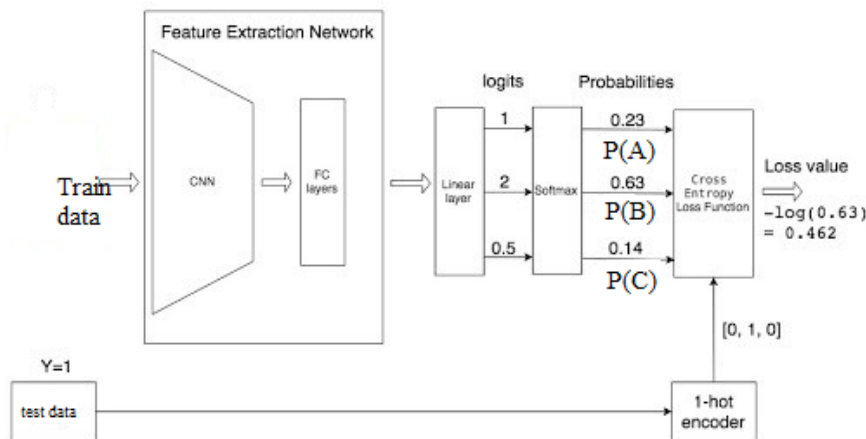

Fig. 3.7: Example of SoftMax classifier with test data.

In the above example we see that 0.462 is the loss of the function for class specific classifier. In the same way, we find loss for remaining classifiers. The lowest the loss function, the better the prediction is. The mathematical representation for loss function can be represented as: -

$$LOSS = np.sum(-Y * np.log(Y_pred))$$

## 4. RESULTS AND DESCRIPTION

This figure depicts a graphical user interface (UI) designed specifically for the analysis of cardiac arrhythmia. It includes various input fields or options for users to input relevant data or parameters related to cardiac health.

Figure shows a bar plot representing the distribution or frequencies of different target classes associated with cardiac arrhythmia. Each bar corresponds to a specific class, providing insights into the distribution of data across different categories.

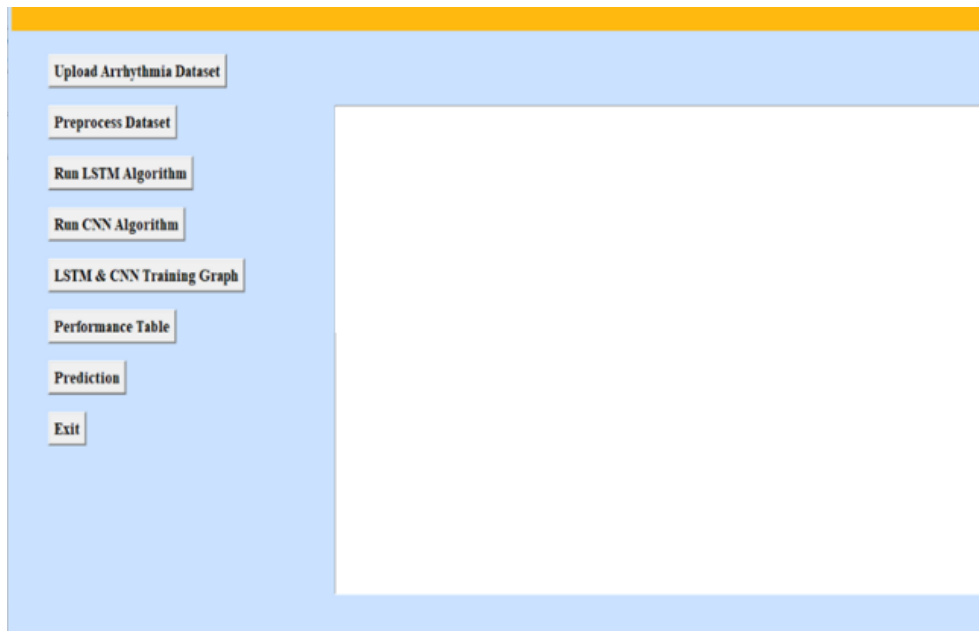

Figure. 1: Sample UI Used for Cardiac Arrhythmia.

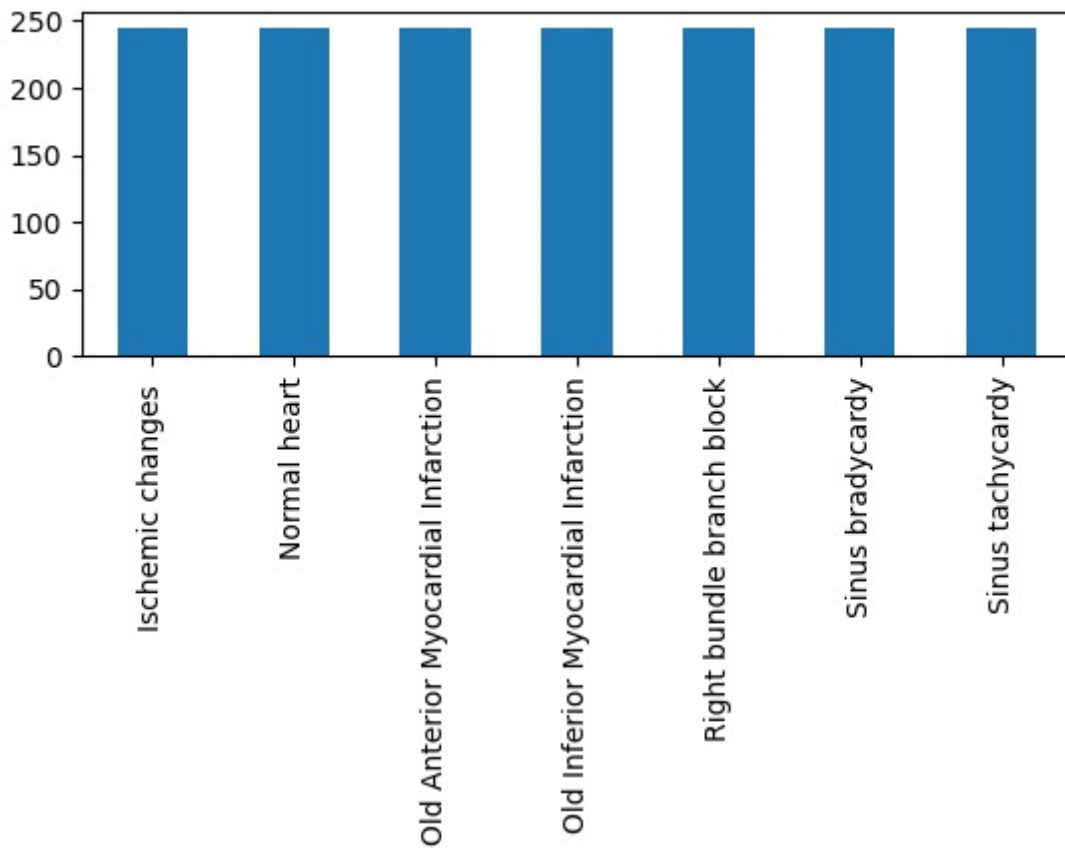

Figure 2: Bar plot of target column used for Cardiac Arrhythmia

# ADVANCED DEEP LEARNING TECHNIQUES FOR THE DETECTION AND CLASSIFICATION OF CARDIAC ARRHYTHMIAS USING IOT-ENABLED ECG SENSOR DATA

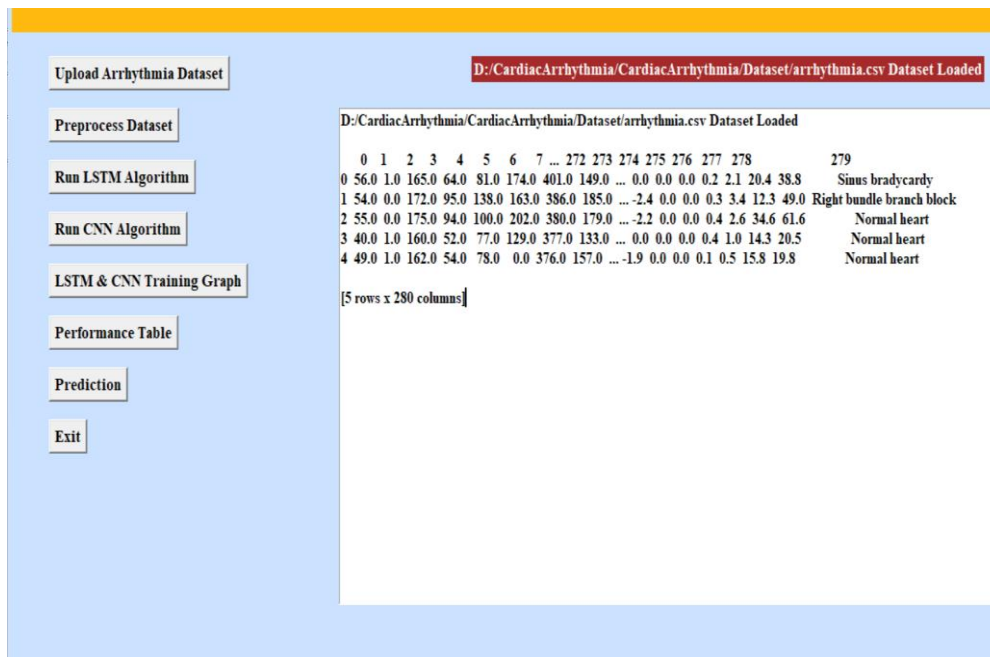

Figure 3: UI After uploading dataset

This figure illustrates the updated state of the user interface following the uploading of a dataset related to cardiac arrhythmia. It includes additional features or options for data visualization, preprocessing, or analysis after the dataset has been loaded.

Figure presents a comparative analysis of the performance of two algorithms, Long Short-Term Memory (LSTM) and Convolutional Neural Network (CNN), in addressing the task of cardiac arrhythmia detection. It includes metrics such as accuracy, precision, recall, and F1-score.

Figure displays the confusion matrix associated with the LSTM algorithm's performance in classifying cardiac arrhythmia instances. The confusion matrix provides a detailed breakdown of true positive, true negative, false positive, and false negative predictions, aiding in the assessment of model performance.



Figure 4: Performance evaluation of Both the algorithms LSTM AND CNN

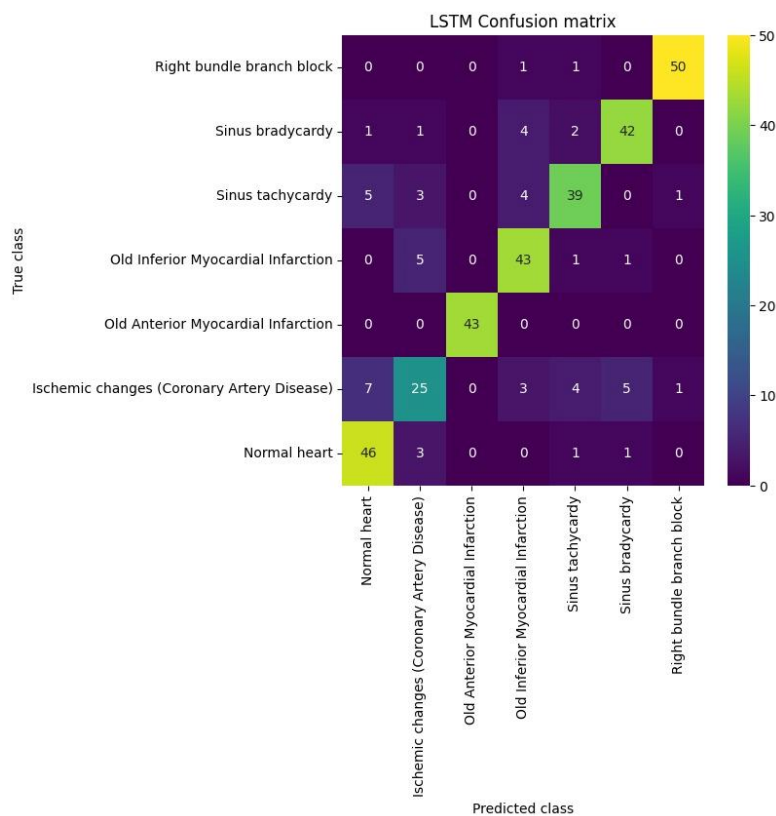

Figure 5: Confusion matrix of LSTM Algorithm

Figure provides a summary or overview of the architecture and parameters of the proposed Convolutional Neural Network (CNN) model designed for cardiac arrhythmia classification. It include details such as the number of layers, kernel sizes, activation functions, and output dimensions.

Similar to Figure 5, this figure depicts the confusion matrix but specifically for the proposed CNN classifier. It offers insights into the classifier's performance in accurately classifying instances of cardiac arrhythmia.



# ADVANCED DEEP LEARNING TECHNIQUES FOR THE DETECTION AND CLASSIFICATION OF CARDIAC ARRHYTHMIAS USING IOT-ENABLED ECG SENSOR DATA

Model: "sequential\_1"

Layer (type)	Output Shape	Param #
conv2d_1 (Conv2D)	(None, 40, 1, 32)	64
max_pooling2d_1 (MaxPooling2)	(None, 40, 1, 32)	0
conv2d_2 (Conv2D)	(None, 40, 1, 32)	1056
max_pooling2d_2 (MaxPooling2)	(None, 40, 1, 32)	0
flatten_1 (Flatten)	(None, 1280)	0
dense_1 (Dense)	(None, 256)	327936
dense_2 (Dense)	(None, 7)	1799

Total params: 330,855  
 Trainable params: 330,855  
 Non-trainable params: 0

Figure 6: Model Summary of Proposed CNN Algorithm.

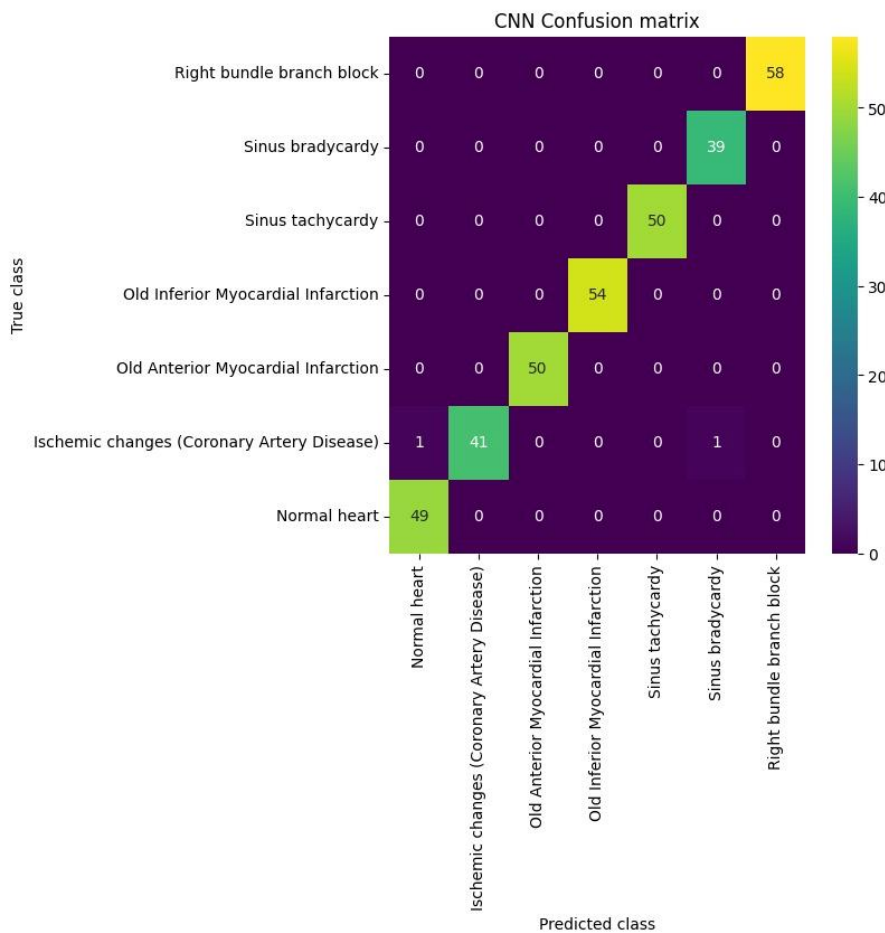

Figure 7: Confusion matrix of Proposed CNN Classifier

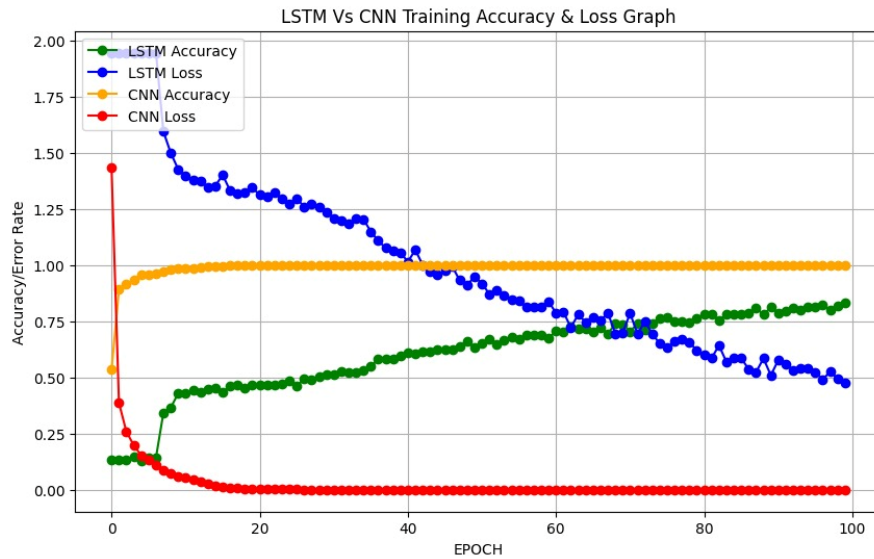

Figure 8: Accuracy and Loss graph of both the Algorithms LSTM AND CNN

Figure presents graphical representations of the accuracy and loss curves for both the LSTM and CNN algorithms during the training process. It allows for the comparison of the algorithms' performance in terms of convergence and generalization on the given dataset.

This table provides a detailed comparison of the performance metrics between the existing LSTM algorithm and the proposed CNN algorithm for cardiac arrhythmia detection. It includes metrics such as accuracy, precision, recall, F1-score, and computational efficiency, facilitating a comprehensive evaluation of both approaches.

Table 1. Performance comparison of Existing LSTM & Proposed CNN

Metric	Existing LSTM	Proposed 1D-CNN
Accuracy	83.38	99.54
Precision	83.075	99.24
Recall	83.0074	99.56
F-Score	82.32	99.24
Sensitivity	100	100
Specificity	91.66	97.28

## 5. CONCLUSION

In this study, we proposed an automated approach, named CardiacNet, for the detection and classification of cardiac arrhythmia using deep learning models. Cardiac arrhythmia poses a significant health risk globally, with a high mortality rate, emphasizing the need for accurate and efficient diagnostic methods. Utilizing ECG signals and employing minimal data pre-processing, we applied

# ADVANCED DEEP LEARNING TECHNIQUES FOR THE DETECTION AND CLASSIFICATION OF CARDIAC ARRHYTHMIAS USING IOT-ENABLED ECG SENSOR DATA

one-dimensional convolutional neural networks (1D-CNN) and long short-term memory (LSTM) networks to automatically detect abnormalities associated with cardiac arrhythmia. We conducted experiments with the MIT-BH dataset, which includes data from seven different stages of arrhythmia diseases. Our findings indicate that while both LSTM and CNN algorithms can be effective in diagnosing cardiac arrhythmia, the existing LSTM model yielded suboptimal accuracy. Consequently, we focused on enhancing performance by adopting the CNN model for training and testing arrhythmia disease classification.

## REFERENCES

- [1] N Jafarnia, Dabanloo, G Attarodi. "A New Pattern Recognition Method for Detection and Localization of Myocardial Infarction Using T-Wave Integral and Total Integral as Extracted Features from One Cycle of ECG Signal". 2014/01/01. Pp 818-824, vol.7, Journal of Biomedical Science and Engineering.
- [2] L. N. Sharma, R. K. Tripathy, and S. Dandapat, "Multiscale Energy and Eigenspace Approach to Detection and Localization of Myocardial Infarction," in IEEE Transactions on Biomedical Engineering, vol. 62, no. 7, pp. 1827-1837, July 2015, doi: 10.1109/TBME.2015.2405134.
- [3] U. R Acharya, H Fujita, Vidya K. Sudarshan, Shu LO, MD Adam, Joel E.W. Koh, JH Tan, Dhanjoo N. Ghista, Roshan Joy Martis, Chua K. Chua, Chua Kok Poo, Ru San Tan. "Automated detection and localization of myocardial infarction using electrocardiogram: a comparative study of different leads", Knowledge-Based Systems, Volume 99, 2016, Pages 146-156, ISSN 0950-7051, <https://doi.org/10.1016/j.knosys.2016.01.040>.
- [4] B. Mohammadzadeh Asl and S. K. Setarehdan, "Neural network-based arrhythmia classification using Heart Rate Variability signal," 2006 14th European Signal Processing Conference, 2006, pp. 1-4.
- [5] . Vishwa-Abhinav, LM Dixit S, P Varadwaj. "Classification Of Arrhythmic ECG Data Using Machine Learning Techniques", International Journal of Interactive Multimedia and Artificial Intelligence, Pp 67-70, vol.1, 2011.
- [6] G Swapna, Dhanjoo N. Ghista, RJ Martis, Alvin P. C. ANG, and SV Sree. "Ecg Signal Generation and Heart Rate Variability Signal Extraction: Signal Processing, Features Detection, And Their Correlation with Cardiac Diseases", Journal of Mechanics in Medicine and Biology, Vol.12, 2012, <https://doi.org/10.1142/S021951941240012X>.
- [7] V. G. Sujadevi, K. P. Soman, R. Vinayakumar, Real-Time Detection of Atrial Fibrillation from Short Time Single Lead ECG Traces Using Recurrent Neural Networks, Intelligent Systems Technologies, and Applications, 2018, Volume 683, ISBN: 978-3-319-68384-3.

- [8] R. K. Pathinarupothi, R. Vinaykumar, E. Rangan, E. Gopalakrishnan and K. P. Soman, "Instantaneous heart rate as a robust feature for sleep apnea severity detection using deep learning," 2017 IEEE EMBS International Conference on Biomedical & Health Informatics (BHI), 2017, pp. 293-296, doi: 10.1109/BHI.2017.7897263.
- [9] Goldberger AL, Amaral LA, Glass L, Hausdorff JM, Ivanov PC, Mark RG, Mietus JE, Moody GB, Peng CK, Stanley HE. Physio Bank, Physio Toolkit, and PhysioNet: components of a new research resource for complex physiologic signals. *Circulation*. 2000 Jun 13;101(23): E215-20. doi: 10.1161/01.cir.101.23. e215. PMID: 10851218.
- [10] F. A. Gers, J. Schmidhuber and F. Cummins, "Learning to forget continual prediction with LSTM," 1999 Ninth International Conference on Artificial Neural Networks ICANN 99. (Conf. Publ. No. 470), 1999, pp. 850-855 vol.2, doi: 10.1049/cp:19991218.
- [11] Ian Goodfellow and Yoshua Bengio and Aaron Courville; *Deep Learning*; Book in preparation for MIT Press; 2016.
- [12] Y. LeCun, L. Bottou, Y. Bengio, P. Haffner, Gradient-based learning applied to document recognition, *Proceedings of the IEEE*, 86(1998), 2278-2324.
- [13] Y. Bengio, Learning deep architectures for AI, *Foundations and Trends in Machine Learning*, 2(2009) 1-127.
- [14] Coşkun, M., Yildirim, Ö., Uçar, A., & Demir, Y. (2017). An Overview of Popular Deep Learning Methods. *European Journal of Technique*, 7(2), 165-176.
- [15] Paweł Pławiak; Novel methodology of cardiac health recognition based on ECG signals and evolutionary-neural system; *Expert Systems with Applications*; 2018; 92; 334 – 349.
- [16] Paweł Pławiak; Novel genetic ensembles of classifiers applied to myocardium dysfunction recognition based on ECG signals; *Swarm and Evolutionary Computation*; 2018; 39; 192 – 208.
- [17] G. B. Moody and R. G. Mark; The impact of the MIT-BIH Arrhythmia Database; *IEEE Engineering in Medicine and Biology Magazine*; 2001; 20; 45-50
- [18] Bengio, Y. (2009). Learning deep architectures for AI. *Foundations and trends in Machine Learning*, 2(1),1-127.
- [19] Reza Moazzezi. (2011) "Change-based population coding." PhD thesis, UCL (University College London).